



*Partner  
for top  
performance*



High-performance  
electrical connections  
[www.techno.it](http://www.techno.it)

MADE IN ITALY



CREATIVITY, TECHNOLOGIES  
AND MATERIALS

*Connection of street lighting LED Luminaires (Rome, Italy). Series TH405.*

High-protection solutions



# In-line Circular joint connectors

Ideal for connections in small spaces and with a high degree of protection (IP68).



## Quick, Re-accessible and Compact

Using the fewest number of components, we ensure that the product is installed in an easy way and in the least possible time.

Totally resin and gel-free, our TEETUBE® solutions are re-accessible even after long operating periods.

Availing ourselves of an innovative design and maximum precision in thermoplastic injection, we realize solutions which are considerably compact, with a high number of poles.



High-protection solutions



# Gasket co-molding

The quality of our materials, innovative proprietary technologies and an accurate analysis of the operative conditions of application allow us to realize and test solutions for electrical connections under the most extreme conditions. Therefore we have decided to supply the market with a revolutionary solution aimed to eliminate the resin sealing of boxes and connectors: **to mold the entire connector in only one solution.**



## Resistance to permanent immersion (IP68)

### High-quality materials

UL94 V0/V2 (f1) materials are suitable for underground installation and guarantee reliability over time. **Products tested up to 10 years.**

### UV radiation resistant

UV radiation resistance test according to EN60079-0. Light ageing method (ISO 4892-2). Duration 1000 hours. Electrical insulation test up to 3.75kV.

### Anti-leakage gaskets

Perfect chemical-mechanical adherence of gaskets which guarantee robustness and reliability in water tightness. **No more installation faults.**



## High-protection solutions



# No more condensation: completely insulated and sealed

Under particular environmental conditions, the accumulation of moisture inside the cable can cause the malfunctioning of electrical devices. The ventilation of the device is not often possible, especially when there is water, debris or in very small spaces. In this case the electrical connection is fundamental to ensure the reliability of the system.



## Reliability guaranteed under extreme conditions

The special anti-moisture barrier prevents the damp inside the cable from entering the connection and proceeding towards the device installed. TEETUBE® connectors are ideal for LED applications with the presence of water and debris (e.g. flooded junction boxes).



LED lighting, architectural, walkable, water submersion, fountains and swimming pools, trade fair stands, lighting displays, big areas.



## High-protection solutions



# Useful for total protection

TEETUBE® connectors can be used in the most various situations, for example in the connection of power and heating cables, as a protection of electronic circuits, in data and optical fiber connections, in motors and pumps.



## Simplified installation:

Pre-wired solutions. It is not necessary to open the box and realize complex wiring.

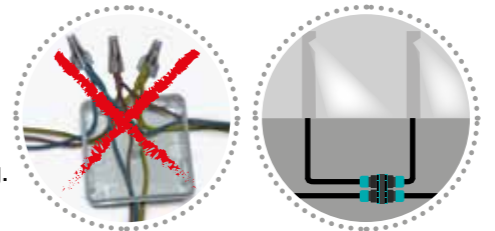

Submersible pumps and engines. Connectors and junctions IP68, resistant to moisture.



Wiring in shipbuilding and cooling containers.



Heating cables connection.

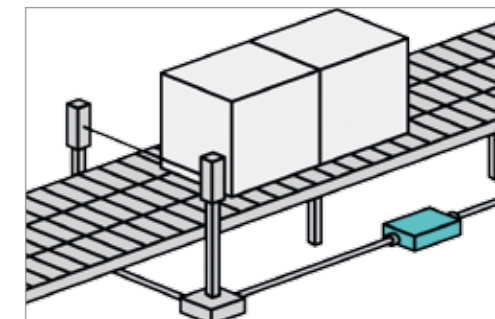

Quick connection junctions for industrial machines.

High-protection solutions



# Quick plug&socket connectors

High-performance cable, wall mount and special connectors (IP68).



### Robust and safe

The quick bayonet coupling junction ferrule with **safety lock-unlock system** guarantees higher resistance to vibrations and mechanical stresses (**guarantee of electrical continuity**). The disconnection is possible only by the use of a tool to prevent accidental displacement.

### Maximum resistance to tensile stress

Under adverse installation conditions (e.g. heavy embossed cables, strong impacts, vibrations, etc.), a special cable block-system ensures perfect resistance to stresses (e.g. tensile stress).



### Powerful and compact

The TEEPLUG® family is characterized by quick plug&socket connection solutions up to 25A 400V. Their compact dimensions are a strong point as an alternative to big industrial sockets with their electrical characteristics being the same.



### Total protection

To ensure better seal, two gaskets have been co-molded on the diameter and on the bottom of the connector to prevent water and dusts from penetrating it. The gaskets are anti-leakage.

IP68



High-protection solutions



# Maximum efficiency in installation and maintenance

The plug&socket connectors and quick junction boxes constitute a **reliable modular interconnection system** which is necessary to guarantee flexibility and quickness in the configuration of a more and more advanced plant. **Reduction of cost of the product installed.**



Lighting of the F1 circuit in Singapore with TH405 connectors.

Public lighting, urban furniture, smart city, CCTVs, data centers, electric signs, car charging stations, etc.

Our materials do not contain sulfur which has a negative effect on the LED lifespan.



High-protection solutions



## Dimensions that make the difference

Compact screw wire connectors meet the most demanding needs of connections in small spaces.



EN61984 certified piercing screw connector for flexible cables from 0.5 to 1.5 mm<sup>2</sup> (17.5A)

### Ultra flat connector.

It is the only 4mm thick connector IP67 on the international market. It has been specifically designed and produced to be used in floor heating plants.

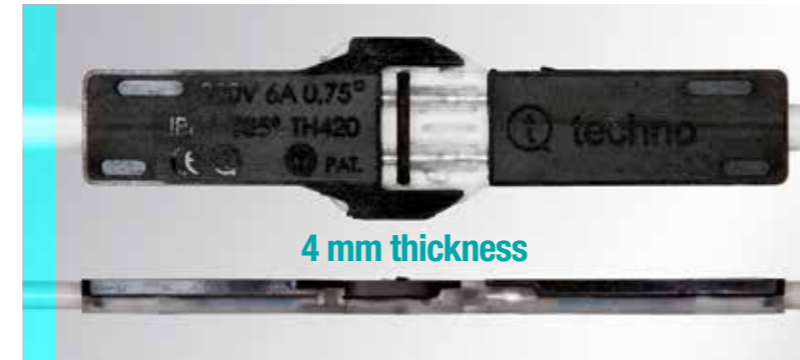

-60%  
Faster  
installations

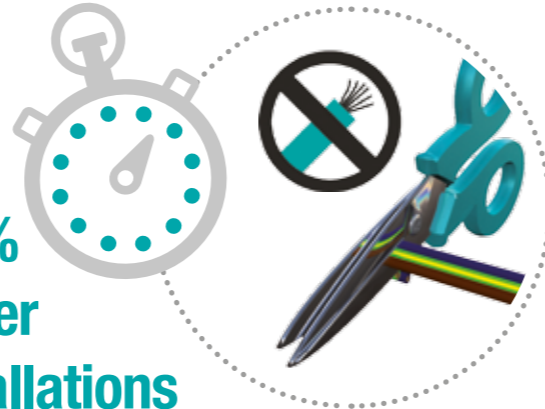

## Quick screw wire and piercing connectors

The wire does not need to be peeled. It is enough to cut the wire and insert it into the wiring terminal. The golden colour screw identifies the insulation piercing connectors. We have available also connectors with standard screw terminal, metal and spring terminal.

## Reliable under extreme conditions

We rely on materials and productive technologies of excellence. We perform stress tests on our products, in addition to the ones provided for by law, to obtain an extremely high level of resistance to moisture, water, dusts and aggressive chemicals. UL94 V2/V0 Yellow Card materials: their exceptional mechanical, temperature and temperature gradients resistance increases the advantages of use further in many sectors.

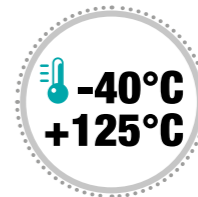

Automation, industrial machines (wood, food and drinks, packaging, bottling, assembly, etc.), robots, control systems, industrial cleaning, engines, civil aeronautics.



High-protection solutions



# Junction boxes and current distributors

Junction boxes with terminal blocks and plug&socket connectors for quick and flexible installations (IP68).



## Attention to minute details

The co-molding gasket guarantees fail-safe installations. The connection hinge between the top and the bottom, obtained directly from the molding of the product, simplifies the installation activities. Cable glands with milled claws built in the box allow the installation of small-section cables.



High-protection solutions



# Protected and compact for maximum versatility

Junction boxes approved up to IP68 guarantee water and dust proof connections without the use of resin or gel.

The boxes are re-accessible thanks to their compact dimensions, they are particularly suitable for connections in small spaces or containing electronic and electromechanical components.



IP68



Residential and industrial electrical installation, junction boxes, gates and doors automation, CCTVs, heating/air-conditioning.

High-protection solutions



## The highest performance in small space

**IP68 ozone**

Resistance to external agents (EN60529). In addition: ageing test in air with ozone concentration (ISO1431-1).



Resistance in saline environment - Corrosion test (EN60068-2-11:2000).

**IK08 IK10**

Resistance to impact (NEMKO - EN62262:2002). IK08 and IP68 tests satisfactory even after conditioning in hydrochloric acid (HCl) for 168 hours at 70°C (pH 4,5 and 3,5). Available versions with IK10.

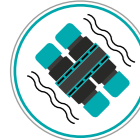

Resistance to vibrations (DEKRA - EN 60068-2-6; RINA RULES 2011 Pt C, Ch 3, Sec 6).

**max GWT 960°C**

Resistance to flame. Use of materials reinforced with fiberglass UL94 V0/V2 (f1). Glow-wire 850°C/960°C.



Realized with materials compliant with the most rigorous Reach/RoHs regulations.

Upon request: low-smoke materials, EMC materials, resistant to ammonium versions. Search for materials and internal laboratory tests upon customer's specification.

Water treatment, monitoring, submersible pumps, energy distribution, petrol stations, mines, processing plant, irrigation, agriculture and cultivation, greenhouse.



Resistant to hydrocarbons (tested according to ISO1817:2001)



High-protection solutions



## Higher flexibility in the configuration of complex plants

3 and 4 ways electrical current distributors (pre-wired boxes with plug&socket connectors) designed to speed up the connection and disconnection of electrical networks and devices of various kind. The access to the terminal block inside the box is not required: it takes advantage of the simplicity and flexibility of a plug&socket connection.

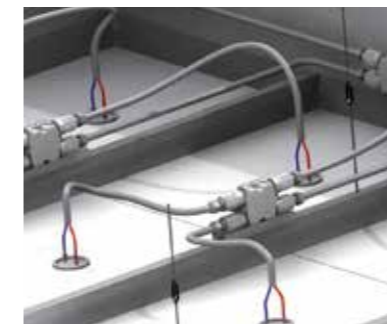

Railway, tram, underground, bus, navigation, shipbuilding, marine lighting, yacht, caravan, light signaling, cable car.

Cable tying solutions



# Innovative cable glands in co-molding

High-protection cable glands (IP68) for quick cable tying.



## Rigorously reliable

### Attention to details

The protective rubber is co-molded also where the cable gland is in contact with any supports. This gives it further reliability and safety, avoiding the use of OR on the thread of the cable gland.

The internal circular rubber crown ensure perfect tightness on the cable. A cable grommet is not needed anymore. Water tightness is guaranteed even in case of excessive nut tightening.

**max 55N**

Approved according to EN50262. Cable tensile test max.55N passed.

**-50m (5bar/1h)**

**IP68**



## More quickness

The use of the TEEGLAND® cable gland allows a considerable saving on installation time. The fastening of the cable and the installation of the cable gland on the panel take only 2-steps and less than 8 seconds.

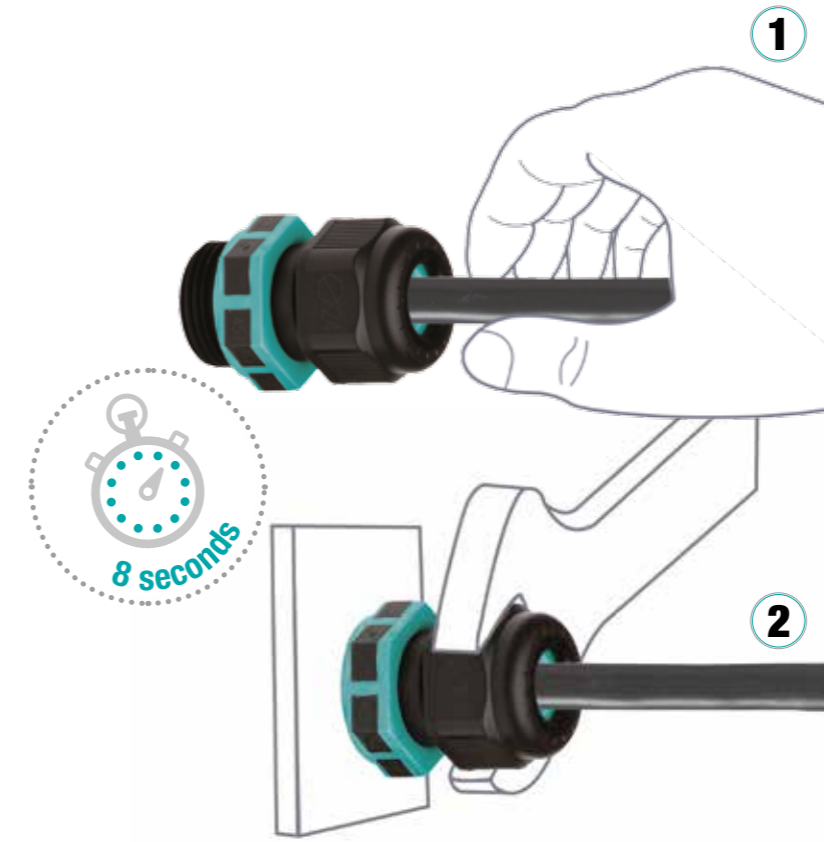

## Fewer assembly faults

The co-molding of the rubber on the techno polymer ensures perfect installation compared to standard cable glands, where the detachment or the wrong position of the gaskets can impair its functioning. The rubber adheres chemically and mechanically to the plastic body and guarantees valid protection from external agents (IP68).



Engines and pumps, heating, air-conditioning, ventilation, industrial refrigerators, SPA, hydro-massage, vending.



Connection solutions



# Compact circular connectors

Individually usable or with TEETUBE® circular joint connectors.



IP20

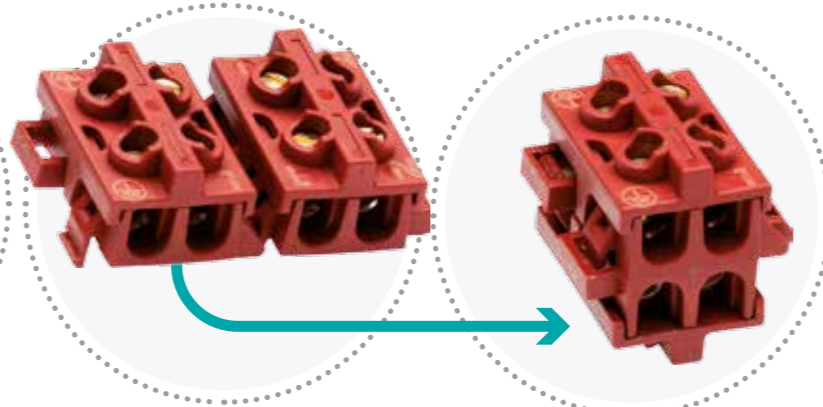

### Modular and compact

Circular connectors, more compact than standard terminal blocks with the same number of poles.

### Useful and versatile

The 4-way terminal block with a hinge makes cable wiring easier in particular situations such as automatic screwing in an industrial process.

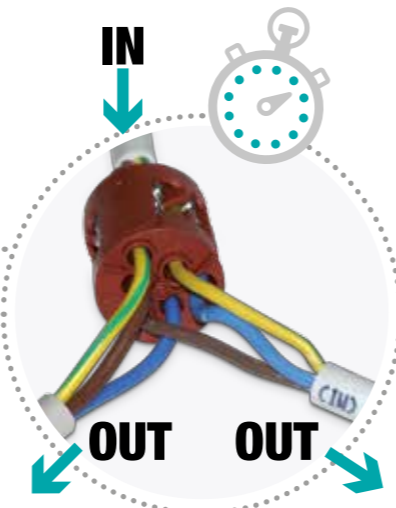
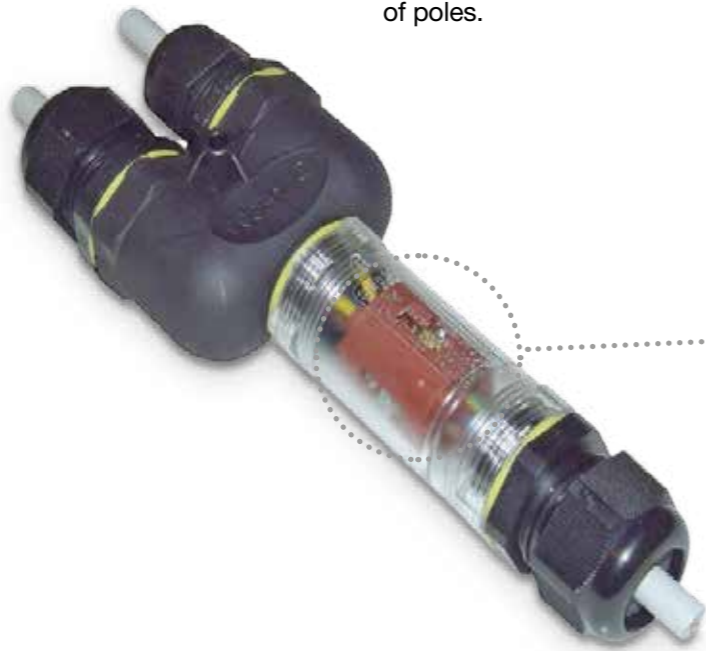

IN

OUT

OUT

Connection solutions



# Compact linear connectors

Individually usable or with TEEBOX® junction boxes.

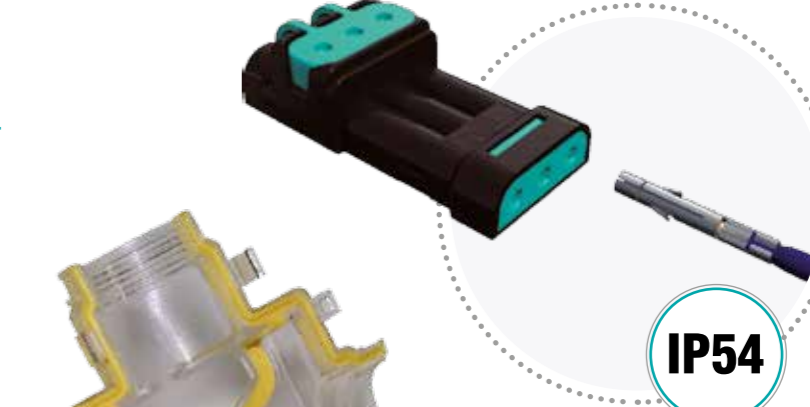
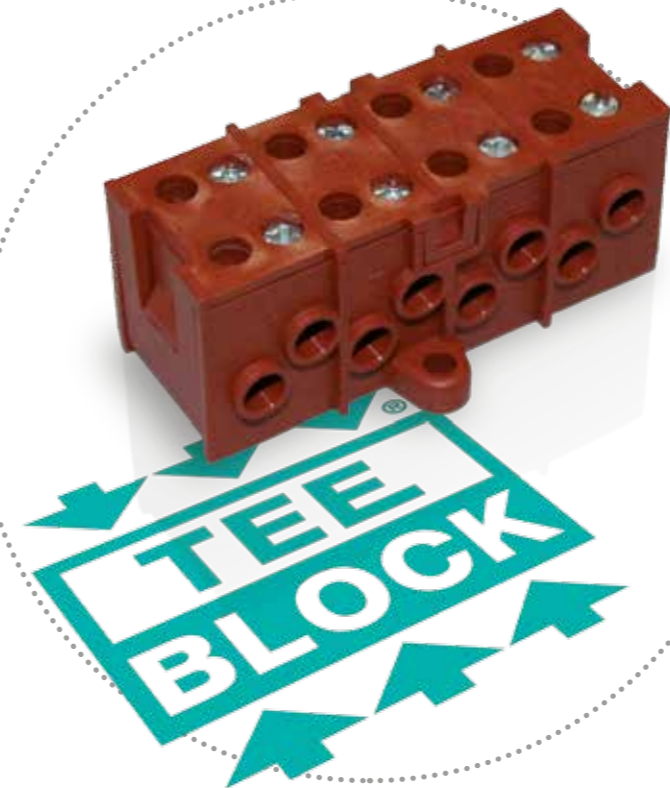

IP54

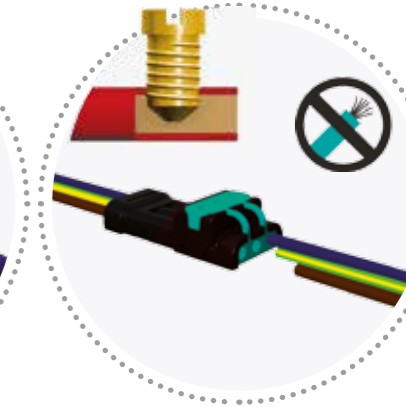

### Reduction of process costs

New connector TH112(IP54). Quick and safe wiring for manufacturers of machinery through the addition of crimps. Cable cutting without peeling for technicians. Reduction of cost of the product installed, quickness and safety thanks to an innovative insulation piercing system.

### Quick wiring

Thanks to a simple internal polarity connection system, there will be no need to twist the three strands of wire anymore. It will be enough to seat them individually in their apposite position in the terminal block to guarantee the correct connection of the poles. The plant will work in complete safety with a considerable advantage in terms of simplicity and quickness of installation.

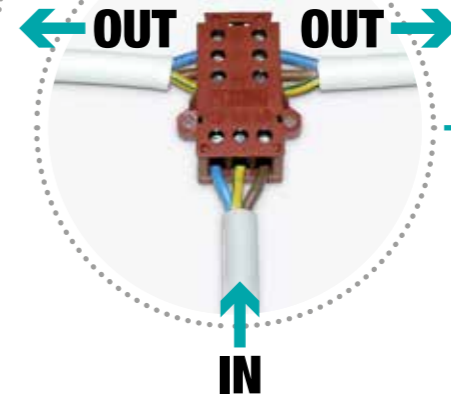
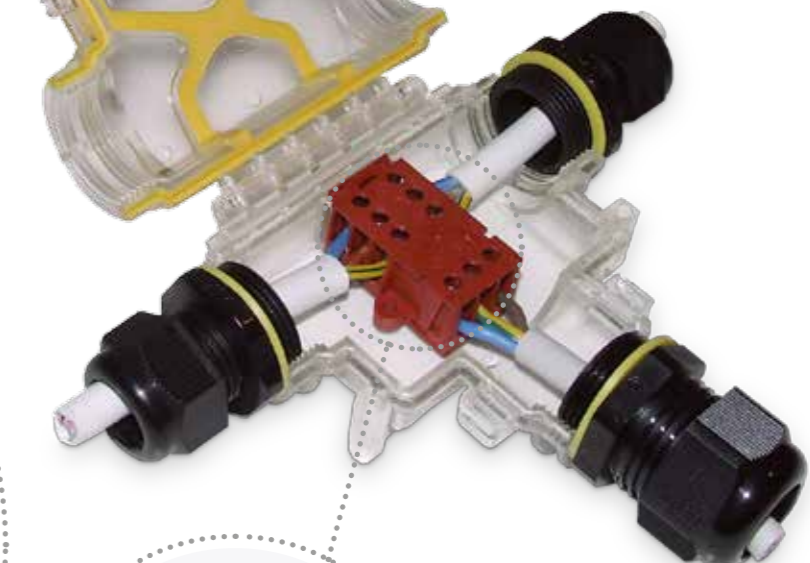

OUT

OUT

IN

# High-performance electrical connections TEEfamily® IP68

## In-line connectors

Number poles<sup>(1)</sup>  
Wire cross-section  
Outer cable diameter<sup>(2)</sup>  
IP protection degree

### Fixed connectors (re-accessible)



TH391	TH390	TH400	TH110
2 ... 4 poles	2 ... 3 poles	2 ... 6 poles	2 ... 3 poles
0.5 - 4.0 mm <sup>2</sup>	0.5 - 4.0 mm <sup>2</sup>	0.5 - 6.0 mm <sup>2</sup>	0.5 - 2.5 mm <sup>2</sup>
7.0 - 13.5 mm	7.0 - 13.5 mm	7.0 - 20.0 mm	5.0 - 9.0 mm
IP68	IP68	IP68	IP44

### Plug&Play connectors



TH381	TH387	TH384	TH405
2 poles	2 ... 5 poles	2 ... 3 poles	2 ... 6 poles
0.25 - 1.0 mm <sup>2</sup>	0.5 - 2.5 mm <sup>2</sup>	0.5 - 2.5 mm <sup>2</sup>	0.5 - 2.5 mm <sup>2</sup>
6.0 - 8.0 mm	7.0 - 13.5 mm	7.0 - 12.0 mm	7.0 - 14.0 mm
IP68	IP68	IP66/IP68	IP68

## Junction connectors

### 3 ways

Number poles<sup>(1)</sup>  
Wire cross-section  
Outer cable diameter<sup>(2)</sup>  
IP protection degree



TH390	TH402	TH399	TH200	TH211
2 ... 3 poles	2 ... 6 poles	2 ... 6 poles	2 ... 3 poles	2 ... 4 poles
0.5 - 1.5 mm <sup>2</sup>	0.5 - 4.0 mm <sup>2</sup>	0.5 - 4.0 mm <sup>2</sup>	0.5 - 1.5 mm <sup>2</sup>	0.5 - 4.0 mm <sup>2</sup>
7.0 - 13.5 mm	7.0 - 20.0 mm	7.0 - 20.0 mm	7.5 - 9.5 mm	7.0 - 17.0 mm
IP68	IP68	IP68	IP67	IP65



TH631	TH370
2 ... 6 poles	2 poles
0.5 - 2.5 mm <sup>2</sup>	2.5 - 6.0 mm <sup>2</sup>
7.0 - 14.0 mm	6.0 - 8.0 mm
IP65	IP68

### 4 ways

Number poles<sup>(1)</sup>  
Wire cross-section  
Outer cable diameter<sup>(2)</sup>  
IP protection degree



TH392	TH209
2 ... 4 poles	2 ... 8 poles
0.5 - 1.5 mm <sup>2</sup>	0.5 - 4.0 mm <sup>2</sup>
7.0 - 13.5 mm	7.0 - 14.0 mm
IP68	IP68



TH623	TH624
2 ... 3 poles	2 ... 5 poles
0.5 - 2.5 mm <sup>2</sup>	0.25 - 2.5 mm <sup>2</sup>
7.0 - 12.0 mm	7.0 - 13.5 mm
IP68	IP68

## Wall mount connectors

Number poles<sup>(1)</sup>  
Wire cross-section  
Outer cable diameter<sup>(2)</sup>  
IP protection degree

### Fixed connectors (re-accessible)



TH391
2 ... 4 poles
0.5 - 4.0 mm <sup>2</sup>
7.0 - 13.5 mm
M20-M25
IP68

### Plug&Play connectors



TH381	TH387	TH385	TH406
2 poles	2 ... 5 poles	2 ... 3 poles	2 ... 6 poles
0.25 - 1.0 mm <sup>2</sup>	0.5 - 2.5 mm <sup>2</sup>	0.5 - 4.0 mm <sup>2</sup>	0.5 - 4.0 mm <sup>2</sup>
6.0 - 8.0 mm	7.0 - 13.5 mm	7.0 - 12.0 mm	7.0 - 14.0 mm
M16	M20-M25	M20-M25	M28
IP68	IP68	IP66/IP68	IP68

## Circular and Linear connectors

Number poles<sup>(1)</sup>  
Wire cross-section  
IP protection degree

### Fixed connectors (re-accessible)

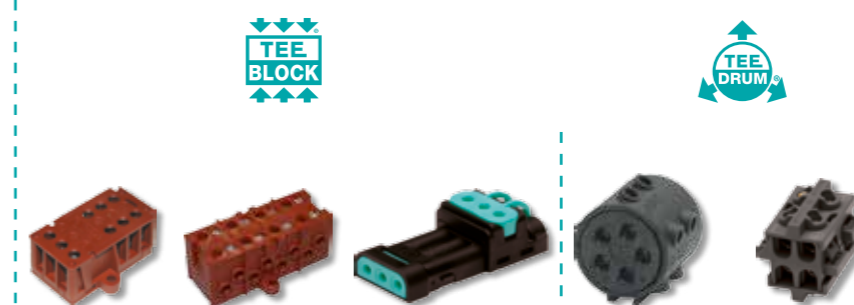

TH029	TH032	TH112	TH021	TH033
2 ... 3 poles	2 ... 4 poles	2 ... 3 poles	2 ... 5 poles	2 ... 4 poles
0.5 - 4.0 mm <sup>2</sup>	0.5 - 4.0 mm <sup>2</sup>	0.5 - 1.5 mm <sup>2</sup>	0.5 - 4.0 mm <sup>2</sup>	0.5 - 4.0 mm <sup>2</sup>
IP00	IP00	IP54	IP20	IP00

## Innovative cable glands in co-molding



Outer cable diameter<sup>(2)</sup>  
IP protection degree



TH450-451-452
4.0 - 17.0 mm
M16 - M20 - M25
PG9 - PG13.5 - PG16
IP68

## mini-TEETUBE®: mini in-line circular joint connectors (IP68)



	Dimensioni esterne (mm)	N. Poli min - max	Sezione conduttore min - max (mm <sup>2</sup> )	Diametro cavo min - max (mm)	Codice	Tipo Cavo (esempio non esaustivo)	Dati Tecnici	Grado IP	Serie	Pezzi/Imballo
 <b>TH391</b>	ø23 x 68	2 - 3 - 4	0.5 - 4.0	7.0 - 12.0	SHORT VERSION <b>THB.391.A4A</b>	max. 4G1.5 FG70R max. 3G2.5 - 2G4 H07RN-F	32A - 450V	IP68 (30m/2h)	TH391	200
	ø23 x 95	2 - 3 - 4	0.5 - 4.0	7.0 - 13.5	LONG VERSION <b>THB.391.A4A.L</b>	max. 4G2.5 FG70R max. 4G4 H07RN-F	32A - 450V	IP68 (30m/2h)	TH391	200
 <b>TH391 xDRY®</b>	ø23 x 85	2 - 3 - 4	0.5 - 4.0	7.0 - 12.0	SHORT VERSION <b>THB.391.R4A<sup>(1)</sup></b>	max. 4G1.5 FG70R max. 3G2.5 - 2G4 H07RN-F	17.5A - 450V	IP68 (30m/2h)	TH391	100
	ø23 x 113	2 - 3 - 4	0.5 - 4.0	7.0 - 13.5	LONG VERSION <b>THB.391.R4A.L<sup>(1)</sup></b>	max. 4G2.5 FG70R max. 4G4 H07RN-F	17.5A - 450V	IP68 (30m/2h)	TH391	100
 <b>TH390</b>	ø32 x 82	2 - 3	0.5 - 4.0	7.0 - 13.5	<b>THB.390.A1A</b>	max. 3G4 FG70R max. 3G4 H07RN-F	32A - 450V	IP68 (50m/1h)	TH390	200

(1) xDRY product with the anti-condensation barrier (see page 4)

## TEETUBE®: in-line circular joint connectors (IP68)





	Dimensioni esterne (mm)	N. Poli min - max	Sezione conduttore min - max (mm <sup>2</sup> )	Diametro cavo min - max (mm)	Codice	Tipo Cavo (esempio non esaustivo)	Dati Tecnici	Grado IP	Serie	Pezzi/Imballo
 <b>TH400</b>	ø32 x 130	2 - 3	0.5 - 4.0	7.0 - 13.5 8.0 - 17.0	<b>THB.400.C1A<sup>(1)</sup></b> <b>THB.400.D1N</b>	max. 3G4 FG70R max. 3G4 H07RN-F	32A - 450V	IP68 (50m/1h)	TH400	200
	ø32 x 130	2 - 3 - 4	0.5 - 4.0	7.0 - 13.5 8.0 - 17.0	<b>THB.400.D1G<sup>(2)</sup></b> <b>THB.400.D1B</b>	max. 4G4 FG70R max. 4G4 H07RN-F	32A - 450V	IP68 (50m/1h)	TH400	200
ø32 x 130	2 - 3 - 4	2.5 - 6.0	7.0 - 13.5 11.0 - 16.0 16.0 - 20.0	<b>THB.400.D4A<sup>(2)</sup></b>	max. 4G6 FG70R max. 4G6 H07RN-F	41A - 750V	IP68 (50m/1h)	TH400	200	
				<b>THB.400.D4C</b>	max. 5G4 FG70R max. 5G4 H07RN-F	32A - 450V	IP68 (50m/1h)	TH400	200	
				<b>THB.400.D4E</b>						
ø32 x 130	2 - 3 - 4 - 5	0.5 - 4.0	7.0 - 13.5 8.0 - 17.0	<b>THB.400.D1H<sup>(2)</sup></b> <b>THB.400.D1A</b>	max. 6G2.5 FG70R max. 6G2.5 H07RN-F	32A - 450V	IP68 (50m/1h)	TH400	200	
ø32 x 130	2 - 3 - 4 - 5 - 6	0.5 - 4.0	7.0 - 13.5 8.0 - 17.0	<b>THB.400.D1L<sup>(2)</sup></b> <b>THB.400.D1D</b>						

(1) External dimensions: ø26.5 mm x 115 mm (2) External dimensions: ø32 mm x 115 mm

## mini-TEETUBE®: mini circular junction connectors - 3/4 ways "H" (IP68)





	Dimensioni esterne (mm)	N. Poli min - max	Sezione conduttore min - max (mm <sup>2</sup> )	Diametro cavo min - max (mm)	Codice	Tipo Cavo (esempio non esaustivo)	Dati Tecnici	Grado IP	Serie	Pezzi/Imballo
 <b>TH392</b>	28 x 54 x 80	2 - 3 - 4	0.5 - 1.5	passante 7.0 - 12.0	<b>THB.392.A4A</b>	max. 4G1.5 FG70R max. 4G1.5 H07RN-F	17.5A - 450V	IP68 (30m/2h)	TH392	50
				derivato 7.0 - 12.0						
 <b>TH392 (3 vie)</b>	28 x 54 x 109	2 - 3 - 4	0.5 - 4.0	passante 7.0 - 13.5	<b>THB.392.A4A.L</b>	max. 4G2.5 FG70R max. 4G4.5 H07RN-F	17.5A - 450V	IP68 (30m/2h)	TH392	50
				derivato 7.0 - 13.5						
 <b>TH392 xDRY®</b>	28 x 54 x 80	2 - 3 - 4	0.5 - 1.5	passante 7.0 - 12.0	<b>THB.392.R4A<sup>(1)</sup></b>	max. 4G1.5 FG70R max. 4G1.5 H07RN-F	17.5A - 450V	IP68 (30m/2h)	TH392	50
				derivato 7.0 - 12.0						
28 x 54 x 109	2 - 3 - 4	0.5 - 4.0	passante 7.0 - 13.5 derivato 7.0 - 13.5	<b>THB.392.R4A.L<sup>(1)</sup></b>	max. 4G2.5 FG70R max. 4G4.5 H07RN-F	17.5A - 450V	IP68 (30m/2h)	TH392	50	
				<b>THB.392.R4B<sup>(1) (2)</sup></b>						
				derivato 7.0 - 13.5	<b>THB.392.R4B.L<sup>(1) (2)</sup></b>					

(1) xDRY product with the anti-condensation barrier (see page 4) (2) Version of 3 ways supplied with closure cap



## TEETUBE®: circular junction connectors - 3 ways "T" (IP68)



	External dimensions (mm)	N. Poles min - max	Wire cross section min - max (mm <sup>2</sup> )	Outer cable diameter min - max (mm)	Code	Cable Type (not exhaustive)	Technical data	IP Grade	Series	Pieces/box
 <b>TH390 "T"</b>	ø32 x 92 x 73	2 - 3	0.5 - 1.5	main 7.0 - 13.5 branch 7.0 - 13.5	<b>THB.390.C1A</b>	max. 3G1.5 FG70R max. 3G1.5 H07RN-F	32A - 450V	IP68 (20m/1h)	TH390	200
	ø32 x 92 x 121	2 - 3	0.5 - 4.0	main 7.0 - 13.5 branch 7.0 - 13.5	<b>THB.402.C2E</b>	max. 3G4 FG70R max. 3G4 H07RN-F	32A - 450V	IP68 (20m/1h)	TH402	200
 <b>TH402</b>	ø32 x 92 x 121	2 - 3 - 4	0.5 - 1.5	main 7.0 - 13.5 branch 8.0 - 17.0	<b>THB.402.D2E</b>	max. 4G1.5 FG70R max. 4G1.5 H07RN-F	32A - 450V	IP68 (20m/1h)	TH402	200
				main 7.0 - 13.5 branch 7.0 - 13.5	<b>THB.402.C1D</b>					
	ø32 x 92 x 121	2 - 3 - 4	1.5 - 4.0	main 7.0 - 13.5 branch 7.0 - 13.5 branch 11.0 - 16.0	<b>THB.402.D1D</b>	max. 4G2.5 FG70R max. 4G2.5 H07RN-F	32A - 450V	IP68 (20m/1h)	TH402	200
					<b>THB.402.C1F</b>					
	ø32 x 92 x 121	2 - 3 - 4 - 5	0.5 - 1.5	main 7.0 - 13.5 branch 7.0 - 13.5 branch 8.0 - 17.0	<b>THB.402.D4A</b>	max. 5G1.5 FG70R max. 5G1.5 H07RN-F	32A - 450V	IP68 (20m/1h)	TH402	200
					<b>THB.402.D4C</b>					
				<b>THB.402.D1F</b>						

## TEETUBE®: circular junction connectors - 3 ways "Y" (IP68)



	External dimensions (mm)	N. Poles min - max	Wire cross section min - max (mm <sup>2</sup> )	Outer cable diameter min - max (mm)	Code	Cable Type (not exhaustive)	Technical data	IP Grade	Series	Pieces/box
 <b>TH399 (mini)</b>	ø32 x 63 x 125	2 - 3	0.5 - 1.5	main 7.0 - 13.5 branch 7.0 - 13.5	<b>THB.399.E3A</b>	max. 3G1.5 FG70R max. 3G1.5 H07RN-F	32A - 450V	IP68 (20m/1h)	TH399	200
	ø32 x 63 x 180	2 - 3	0.5 - 4.0	main 7.0 - 13.5 branch 7.0 - 13.5	<b>THB.399.A9B</b>	max. 3G4 FG70R max. 3G4 H07RN-F	32A - 450V	IP68 (20m/1h)	TH399	100
 <b>TH399</b>	ø32 x 63 x 180	2 - 3 - 4	0.5 - 1.5	main 8.0 - 17.0 branch 8.0 - 17.0	<b>THB.399.D9B</b>	max. 4G1.5 FG70R max. 4G1.5 H07RN-F	32A - 450V	IP68 (20m/1h)	TH399	100
				main 7.0 - 13.5 branch 7.0 - 13.5	<b>THB.399.A4A</b>					
	ø32 x 63 x 180	2 - 3 - 4	1.5 - 4.0	main 8.0 - 17.0 branch 8.0 - 17.0	<b>THB.399.D4A</b>	max. 4G4 FG70R max. 4G4 H07RN-F	32A - 450V	IP68 (20m/1h)	TH399	100
					<b>THB.399.A4E</b>					
	ø32 x 63 x 180	2 - 3 - 4	0.5 - 1.5	main 7.0 - 13.5 branch 7.0 - 13.5 branch 11.0 - 16.0	<b>THB.399.A4E</b>	max. 5G1.5 FG70R max. 5G1.5 H07RN-F	32A - 450V	IP68 (20m/1h)	TH399	100
					<b>THB.399.D4E</b>					
				<b>THB.399.A5A</b>						
				main 7.0 - 13.5 branch 7.0 - 13.5 branch 8.0 - 17.0	<b>THB.399.D5A</b>					

## mini-TEETUBE®: mini wall mount circular joint connectors (IP68)



TH391 (M20 nut)



TH391 (M25 nut)



Example

External dimensions (mm)	N. Poles min - max	Wire cross section min - max (mm <sup>2</sup> )	Outer cable diameter min - max (mm)	Code <sup>(1)</sup>	Thread	Cable Type (not exhaustive)	Technical data	IP Grade	Series	Pieces/box
ø23 x 35	2 - 3 - 4	0.5 - 4.0	7.0 - 12.0	THB.391.B4A <sup>(2)</sup>	M20	max. 4G1.5 FG70R max 4G1.5 - 3G2.5 - 2G4 H07RN-F	32A - 450V	IP68 (30m/2h)	TH391	200
ø23 x 50	2 - 3 - 4	0.5 - 4.0	7.0 - 13.5	THB.391.B4A.L <sup>(2)</sup>	M20	max. 4G2.5 FG70R max 4G4 H07RN-F	32A - 450V	IP68 (30m/2h)	TH391	200
ø23 x 48	2 - 3 - 4	0.5 - 4.0	7.0 - 12.0	THB.391.H4A	M20	max. 4G1.5 FG70R max 4G1.5 - 3G2.5 - 2G4 H07RN-F	32A - 450V	IP68 (30m/2h)	TH391	200
ø23 x 63	2 - 3 - 4	0.5 - 4.0	7.0 - 13.5	THB.391.H4A.L	M20	max. 4G2.5 FG70R max 4G4 H07RN-F	32A - 450V	IP68 (30m/2h)	TH391	200
ø23 x 38	2 - 3 - 4	0.5 - 4.0	7.0 - 12.0	THB.391.L4A	M25	max. 4G1.5 FG70R max 4G1.5 - 3G2.5 - 2G4 H07RN-F	32A - 450V	IP68 (30m/2h)	TH391	200
ø23 x 53	2 - 3 - 4	0.5 - 4.0	7.0 - 13.5	THB.391.L4A.L	M25	max. 4G2.5 FG70R max 4G4 H07RN-F	32A - 450V	IP68 (30m/2h)	TH391	200
ø23 x 53	2 - 3 - 4	0.5 - 4.0	7.0 - 12.0	THB.391.D4A <sup>(2)(3)</sup>	M20	max. 4G1.5 FG70R max 4G1.5 - 3G2.5 - 2G4 H07RN-F	17.5A - 450V	IP68 (30m/2h)	TH391	100
ø23 x 68	2 - 3 - 4	0.5 - 4.0	7.0 - 13.5	THB.391.D4A.L <sup>(2)(3)</sup>	M20	max. 4G2.5 FG70R max 4G4 H07RN-F	17.5A - 450V	IP68 (30m/2h)	TH391	100
ø23 x 66	2 - 3 - 4	0.5 - 4.0	7.0 - 12.0	THB.391.N4A <sup>(3)</sup>	M20	max. 4G1.5 FG70R 4G1.5 - 3G2.5 - 2G4 H07RN-F	17.5A - 450V	IP68 (30m/2h)	TH391	100
ø23 x 81	2 - 3 - 4	0.5 - 4.0	7.0 - 13.5	THB.391.N4A.L <sup>(3)</sup>	M20	max. 4G2.5 FG70R max 4G4 H07RN-F	17.5A - 450V	IP68 (30m/2h)	TH391	100
ø23 x 56	2 - 3 - 4	0.5 - 4.0	7.0 - 12.0	THB.391.T4A <sup>(3)</sup>	M25	max. 4G1.5 FG70R 4G1.5 - 3G2.5 - 2G4 H07RN-F	17.5A - 450V	IP68 (30m/2h)	TH391	100
ø23 x 71	2 - 3 - 4	0.5 - 4.0	7.0 - 13.5	THB.391.T4A.L <sup>(3)</sup>	M25	max. 4G2.5 FG70R max 4G4 H07RN-F	17.5A - 450V	IP68 (30m/2h)	TH391	100

(1) Supplied with the fixing nut (2) Only for plastic panels or Class III (SELV) devices (3) xDRY product with the anti-condensation barrier (see page 4)

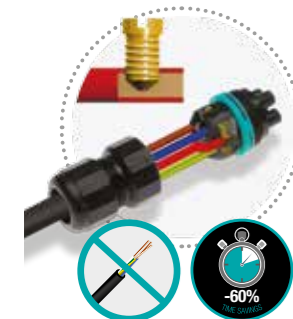

**Products with piercing screw terminal blocks** (see page 8)  
In addition to products with screw terminal blocks, piercing screw connectors are available for cable section from 0.5 mm<sup>2</sup> to 1.5mm<sup>2</sup> (max. 17.5A). Approved with PVC, Neoprene and FEP cables.

How to order CODE THP.xxx.xxx  
example

THP.391.A4A  
products with piercing screws

THB.391.A4A  
products with standard screws



Transparent and colour versions upon customer request.



Compatible with cable protection systems and spiral tops.



Versions with over-molded cable upon customer request.



Special versions. Learn more on [www.techno.it](http://www.techno.it)



Wide range of accessories for cables of various kind.

## TEEBOX®: In-out junction box with terminal block (IP44)

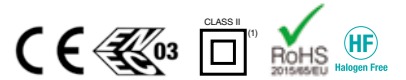

External dimensions (mm)	N. Poles min - max	Wire cross section min - max (mm <sup>2</sup> )	Outer cable diameter min - max (mm)	Code	Cable Type (not exhaustive)	Technical data	IP Grade	Series	Pieces/box
75 x 39 x 13.5	2	0.5 - 2.5	5.0 - 9.0	THB.110.C2A <sup>(1)</sup>	max. 2G2.5 - 3G2.5 H05SS-F, H05VV-F, H05RR-F	24A - 450V	IP44	TH110	600
75 x 39 x 13.5	3	0.5 - 2.5	5.0 - 9.0	THB.110.C3A		24A - 450V	IP44	TH110	600



TH110 (2poles)



TH110 (3poles)

(1) Approved for use with class 2 devices

## TEEBOX®: Junction boxes with terminal block - 3 ways "T" (IP65/IP67)



External dimensions (mm)	N. Poles min - max	Wire cross section min - max (mm <sup>2</sup> )	Outer cable diameter min - max (mm)	Code <sup>(1)</sup>	Cable Type (not exhaustive)	Technical data	IP Grade	Series	Pieces/box
70 x 82 x 20	2 - 3	0.5 - 1.5	main 7.5 - 9.5 branch 7.5 - 9.5	THB.200.E3F	max. 3G1.5 H07RN-F	16A - 250V	IP67	TH200	200
137 x 118 x 36	2 - 3	0.5 - 4.0	main 7.0 - 13.5 branch 7.0 - 13.5	THB.211.D3A	max. 3G4 FG70R max. 3G4 H07RN-F	24A - 450V	IP65	TH211	50
137 x 118 x 36	2 - 3	0.5 - 4.0	main 8.0 - 17.0 branch 8.0 - 17.0	THB.211.A3A	max. 3G4 FG70R max. 3G4 H07RN-F	24A - 450V	IP65	TH211	50
137 x 118 x 36	2 - 3 - 4	0.5 - 4.0	main 8.0 - 17.0 branch 8.0 - 17.0	THB.211.A4A	max. 4G4 FG70R max. 4G4 H07RN-F	16A - 450V	IP65	TH211	50



TH200



TH211

(1) Supplied with the terminal block Note: versions with more poles available upon request. Learn more on [www.techno.it](http://www.techno.it)

## TEEBOX®: Junction boxes with terminal block - 3/4 ways "H" (IP68)



External dimensions (mm)	N. Poles min - max	Wire cross section min - max (mm <sup>2</sup> )	Outer cable diameter min - max (mm)	Code <sup>(1)</sup>	Cable Type (not exhaustive)	Technical data	IP Grade	Series	Pieces/box
108 x 65 x 28	2 - 3	0.5 - 4.0	main 7.0 - 14.0 branch 7.0 - 14.0	THB.209.A3A <sup>(2)</sup>	max. 3G4 FG70R max. 3G4 H07RN-F	24A - 450V	IP68 (5m/3h)	TH209	100
108 x 65 x 28	2 - 3 - 4	0.5 - 2.5	main 7.0 - 14.0 branch 7.0 - 14.0	THB.209.A4A	max. 4G2.5 FG70R max. 4G2.5 H07RN-F	24A - 450V	IP68 (5m/3h)	TH209	100
108 x 65 x 28	5	0.5 - 1.5	main 7.0 - 14.0 branch 7.0 - 14.0	THB.209.A5A	max. 5G1.5 FG70R max. 5G1.5 H07RN-F	16A - 450V	IP68 (5m/3h)	TH209	100
108 x 65 x 28	8	0.5 - 1.5	main 7.0 - 14.0 branch 7.0 - 14.0	THB.209.A8A	max. 8G1 H07RN-F	16A - 450V	IP68 (5m/3h)	TH209	100
108 x 65 x 28	-	-	main 7.0 - 14.0 branch 7.0 - 14.0	THA.219.A1A <sup>(3)</sup>	-	16A - 450V	IP68 (5m/3h)	TH209	100



TH209





TH219

(1) Supplied with the terminal block (2) Version of 3 ways supplied with closure cap (3) Empty box to be filled with the resin (resin not included)

## TEEBOX®: Pre-wired junction boxes with plug&socket connectors 3 ways “T” (IP65)







	External dimensions (mm) <sup>(2)</sup>	N. Poles min - max	Wire cross section min - max (mm <sup>2</sup> )	Outer cable diameter min - max (mm)	Code <sup>(1)</sup>	Cable Type (not exhaustive)	Technical data	IP Grade	Series	Pieces/box
 <b>TH631</b>	235 x 159 x 43	2 - 3	0.5 - 2.5	main 7.0 - 14.0 branch 7.0 - 14.0	<b>THH.631.B3A</b>	max. 3G2.5 FG70R max. 3G2.5 H07RN-F	25A - 400V	IP65	TH631	50
 <b>TH631</b>	235 x 159 x 43	2 - 3 - 4 - 5	0.5 - 1.5	main 7.0 - 14.0 branch 7.0 - 14.0	<b>THH.631.B5A</b>	max. 5G1.5 FG70R max. 5G1.5 H07RN-F	17.5A - 400V	IP65	TH631	50

(1) Supplied with plug&socket connectors (2) Dimensions are intended when the connectors are inserted

## TEEBOX®: Pre-wired junction boxes with plug&socket connectors 4 ways “H” (IP68)



	External dimensions (mm) <sup>(2)</sup>	N. Poles min - max	Wire cross section min - max (mm <sup>2</sup> )	Outer cable diameter min - max (mm)	Code	Cable Type (not exhaustive)	Technical data	IP Grade	Series	Pieces/box
 <b>TH623</b>	200 x 65 x 28	2 - 3	0.5 - 1.5	main 7.0 - 9.5 branch 7.0 - 9.5	<b>THH.623.B3A</b> <sup>(1)</sup>	max. 3G1.5 FG70R max. 3G1.5 H07RN-F	17.5A - 400V	IP40	TH623	50
 <b>TH623</b>	200 x 65 x 28	2 - 3	0.5 - 2.5	main 7.0 - 12.0 branch 7.0 - 12.0	<b>THH.623.L3A</b> <sup>(1)</sup>	max. 3G2.5 FG70R max. 3G2.5 H07RN-F	17.5A - 400V	IP68 (5m/3h)	TH623	50
 <b>TH624</b>	135 x 60 x 23	2 - 3 - 4		see TH387	<b>THH.624.A4A</b> <sup>(3)</sup>	see TH387	17.5A - 400V	IP68 (30m/2h)	TH624	50
 <b>TH624</b>	135 x 60 x 23	2 - 3 - 4 - 5		see TH387	<b>THH.624.A5A</b> <sup>(3)</sup>	see TH387	17.5A - 400V	IP68 (30m/2h)	TH624	50

(1) Supplied with plug&socket connectors (2) Dimensions are intended when the connectors are inserted (3) Connectors must be ordered separately (series TH387)



**Products with piercing screw terminal blocks** (see page 8)  
In addition to products with screw terminal blocks, piercing screw connectors are available for cable section from 0.5 mm<sup>2</sup> to 1.5mm<sup>2</sup> (max. 17.5A). Approved with PVC, Neoprene and FEP cables.

How to order CODE THP.xxx.xxx  
example

THP.391.A4A  
products with piercing screws

THB.391.A4A  
products with standard screws



Colour and personalized versions upon customer request.



Transparent versions for easy check of the connection.



Hybrid and pre-wired solutions upon customer request.









Learn more about the TEEBOX® range on [www.techno.it](http://www.techno.it)

To learn more about products, accessories and technical information see our **General Catalogue** or visit [www.techno.it](http://www.techno.it)

## mini-TEEPLUG®: mini plug&socket connectors (IP66/IP68)





	External dimensions (mm) <sup>(1)</sup>	N. Poles min - max	Wire cross section min - max (mm <sup>2</sup> )	Outer cable diameter min - max (mm)	Code	Connector type	Cable Type (not exhaustive)	Technical data	IP Grade	Series	Pieces/box
 <b>TH381</b>	ø14 x 84	2	0.25 - 1.0	6.0 - 8.0	<b>THB.381.A2A</b> <sup>(3)</sup>	plug	max. 2G1 H07RN-F	10A - 400V	IP68 (30m/1h)	TH381	200
					<b>THB.381.B2A</b> <sup>(3)</sup>	socket	max. 2G1 H07RN-F	10A - 400V	IP68 (30m/1h)	TH381	200
 <b>TH384</b>	ø27 x 95	2 - 3	0.5 - 2.5	7.0 - 12.0	<b>THB.384.A1A</b> <sup>(3)</sup>	plug	max. 3G2.5 FG70R max. 3G2.5 H07RN-F	17.5A - 400V	IP66/IP68 (50m/24h)	TH384	200
					<b>THB.384.B1A</b> <sup>(3)</sup>	socket	max. 3G2.5 FG70R max. 3G2.5 H07RN-F	17.5A - 400V	IP66/IP68 (50m/24h)	TH384	200
 <b>TH387</b>	ø23 x 85	2 - 3 - 4	0.5 - 2.5	7.0 - 12.0	<b>THB.387.A4A</b> <sup>(3)</sup>	plug	max. 3G2.5/4G1.5 FG70R max. 3G2.5/4G1.5 H07RN-F	17.5A - 450V	IP68 (30m/3h)	TH387	200
					<b>THB.387.B4A</b> <sup>(3)</sup>	socket	max. 3G2.5/4G1.5 FG70R max. 3G2.5/4G1.5 H07RN-F	17.5A - 450V	IP68 (30m/3h)	TH387	200
 <b>TH387</b>	ø23 x 113	2 - 3 - 4	0.5 - 2.5	7.0 - 13.5	<b>THB.387.A4A.L</b> <sup>(3)</sup>	plug	max. 4G2.5 FG70R max. 4G2.5 H07RN-F	17.5A - 450V	IP68 (30m/3h)	TH387	200
					<b>THB.387.B4A.L</b> <sup>(3)</sup>	socket	max. 4G2.5 FG70R max. 4G2.5 H07RN-F	17.5A - 450V	IP68 (30m/3h)	TH387	200
 <b>TH387</b>	ø23 x 85	2 - 3 - 4 - 5	0.35 - 1.5	7.0 - 12.0	<b>THB.387.A5A</b>	plug	max. 5G1.5 FG70R max. 5G1.5 H07RN-F	17.5A - 450V	IP68 (30m/3h)	TH387	200
					<b>THB.387.B5A</b>	socket	max. 5G1.5 FG70R max. 5G1.5 H07RN-F	17.5A - 450V	IP68 (30m/3h)	TH387	200
 <b>TH387</b>	ø23 x 113	2 - 3 - 4 - 5	0.25 - 2.5	7.0 - 13.5	<b>THB.387.A5A.L</b>	plug	max. 5G2.5 FG70R max. 5G2.5 H07RN-F	17.5A - 450V	IP68 (30m/3h)	TH387	200
					<b>THB.387.B5A.L</b>	socket	max. 5G2.5 FG70R max. 5G2.5 H07RN-F	17.5A - 450V	IP68 (30m/3h)	TH387	200

(1) Dimensions are intended when the connectors are inserted (2) UL approvals only for the TH384 series – 3 poles (learn more on [www.techno.it](http://www.techno.it))

(3) Approved for use with class 2 devices (only for 2 poles versions)

## TEEPLUG®: plug&socket connectors with safety lock-unlock system (IP68)



	External dimensions (mm) <sup>(1)</sup>	N. Poles min - max	Wire cross section min - max (mm <sup>2</sup> )	Outer cable diameter min - max (mm)	Code	Connector type	Cable Type (not exhaustive)	Technical data	IP Grade	Series	Pieces/box
 <b>TH405</b>	ø36.5 x 130	2 - 3	0.5 - 2.5	7.0 - 14.0	<b>THB.405.A2B</b> <sup>(4)</sup>	plug	max. 3G2.5 FG70R max. 3G2.5 H07RN-F	25A - 400V	IP68 (10m/1h)	TH405	200
					<b>THB.405.B2B</b> <sup>(4)</sup>	socket	max. 3G2.5 FG70R max. 3G2.5 H07RN-F	25A - 400V	IP68 (10m/1h)	TH405	200
 <b>TH405</b>	ø36.5 x 130	2 - 3 - 4 - 5	0.5 - 1.5	7.0 - 14.0	<b>THB.405.A2A</b>	plug	max. 5G1.5 FG70R max. 5G1.5 H07RN-F	17.5A - 400V	IP68 (10m/1h)	TH405	200
					<b>THB.405.B2A</b>	socket	max. 5G1.5 FG70R max. 5G1.5 H07RN-F	17.5A - 400V	IP68 (10m/1h)	TH405	200
 <b>TH405</b>	ø36.5 x 130	2 - 3 - 4 - 5 - 6	0.5 - 1.5	7.0 - 14.0	<b>THB.405.A2E</b>	plug	max. 6G1.5 FG70R max. 6G1.5 H07RN-F	17.5A - 400V	IP68 (10m/1h)	TH405	200
					<b>THB.405.B2E</b>	socket	max. 6G1.5 FG70R max. 6G1.5 H07RN-F	17.5A - 400V	IP68 (10m/1h)	TH405	200

(1) Dimensions are intended when the connectors are inserted (2) UL approvals only for 3 and 5 poles (learn more on [www.techno.it](http://www.techno.it))

(3) Approved for use with class 2 devices (only for 2 poles versions) (4) Tested up to 32 Amp with 3G4 cable

## TEEPLUG®: plug&socket connectors (IP65)



External dimensions (mm) <sup>(1)</sup>	N. Poles min - max	Wire cross section min - max (mm <sup>2</sup> )	Outer cable diameter min - max (mm)	Code	Connector type	Cable Type (not exhaustive)	Technical data	IP Grade	Series	Pieces/box
ø42 x 130	2 - 3	0.5 - 2.5	7.0 - 14.0	THB.404.A2B	plug	max. 3G2.5 FG7OR	25A - 400V	IP65	TH404	200
				THB.404.B2B	socket	max. 3G2.5 H07RN-F				200
ø42 x 130	2 - 3 - 4 - 5	0.5 - 1.5	7.0 - 14.0	THB.404.A2A	plug	max. 5G1.5 FG7OR	17.5A - 400V	IP65	TH404	200
				THB.404.B2A	socket	max. 5G1.5 H07RN-F				200
ø42 x 130	2 - 3 - 4 - 5 - 6	0.5 - 1.5	7.0 - 14.0	THB.404.A2E	plug	max. 6G1.5 FG7OR	17.5A - 400V	IP65	TH404	200
				THB.404.B2E	socket	max. 6G1.5 H07RN-F				200

(1) Dimensions are intended when the connectors are inserted (2) Approved for use with class 2 devices (only for TH404 series 2 poles)

## mini-TEEPLUG®: mini wall mount plug&socket connectors (IP66/IP68)



External dimensions (mm) <sup>(1)</sup>	N. Poles min - max	Wire cross section min - max (mm <sup>2</sup> )	Code <sup>(2)(3)</sup>	Thread	Technical data	IP Grade	Series	Pieces/box
ø14 x 84	2	0.25 - 1.0	THB.381.L2A	M16	10A - 400V	IP68 (30m/1h)	TH381	200
ø27 x 72	2 - 3	0.5 - 4.0	THB.385.A3D	M20	17.5A - 400V	IP66/IP68 (50m/24h)	TH385	200
ø27 x 72	2 - 3	0.5 - 4.0	THB.385.A1A	M25	17.5A - 400V	IP66/IP68 (50m/24h)	TH385	200
ø23 x (48÷63)	2 - 3 - 4	0.5 - 2.5	THB.387.L4A	M20 <sup>(5)</sup>	17.5A - 450V	IP68 (30m/3h)	TH387	200
ø23 x (61÷76)	2 - 3 - 4	0.5 - 2.5	THB.387.N4A	M20	17.5A - 450V	IP68 (30m/3h)	TH387	200
ø23 x (51÷66)	2 - 3 - 4	0.5 - 2.5	THB.387.E4A	M25	17.5A - 400V	IP68 (30m/3h)	TH387	200
ø23 x (48÷63)	2 - 3 - 4 - 5	0.25 - 1.5	THB.387.L5A	M20 <sup>(5)</sup>	17.5A - 450V	IP68 (30m/3h)	TH387	200
ø23 x (61÷76)	2 - 3 - 4 - 5	0.25 - 1.5	THB.387.N5A	M20	17.5A - 450V	IP68 (30m/3h)	TH387	200
ø23 x (51÷66)	2 - 3 - 4 - 5	0.25 - 1.5	THB.387.E5A	M25	17.5A - 450V	IP68 (30m/3h)	TH387	200

(1) Dimensions are intended when the connectors are inserted

(3) Supplied with the fixing nut

(5) Only for plastic panels or Class III (SELV) devices.

(2) Plug versions. For related socket versions see codes of the TH384 (for codes of TH385) and TH381, TH387.

(4) UL approvals only for THB.385.A1A (learn more on [www.techno.it](http://www.techno.it))

(6) Approved for use with class 2 devices: only for TH385 2 poles and TH387 2 poles

With fixing nut



**Products with piercing screw terminal blocks (see page 8)**  
In addition to products with screw terminal blocks, piercing screw connectors are available for cable section from 0.5 mm<sup>2</sup> to 1.5mm<sup>2</sup> (max. 17.5A). Approved with PVC, Neoprene and FEP cables.

**How to order CODE THP.xxx.xxx**  
example

THP.391.A4A  
products with piercing screws

THB.391.A4A  
products with standard screws



Colour and personalized versions upon request.

Transparent versions for easy check of the connection.

Versions with over-molded cable upon customer request.

Wide range of accessories for cables of various kind.

## mini-TEEPLUG®: mini wall mount quick-fix plug&socket connectors (IP67)



Quick-fix system

External dimensions (mm) <sup>(1)</sup>	N. Poles min - max	Wire cross section min - max (mm <sup>2</sup> )	Code <sup>(2)</sup>	Panel Hole (mm)	Technical data	IP Grade	Series	Pieces/box
ø27 x 72	2 - 3	0.5 - 4.0	THB.386.A1A	ø25	17.5A - 400V	IP67	TH386	200

(1) Dimensions are intended when the connectors are inserted (2) Plug versions. For related socket versions see codes of the TH384 series

## mini-TEEPLUG®: mini wall mount plug&socket connectors 90° angled (IP66/IP68)



With fixing nut

External dimensions (mm) <sup>(1)</sup>	N. Poles min - max	Wire cross section min - max (mm <sup>2</sup> )	Code <sup>(2)(3)</sup>	Thread	Technical data	IP Grade	Series	Pieces/box
ø27 x 35 x 100	2 - 3	0.5 - 4.0	THB.385.A3F	M20	17.5A - 400V	IP66/IP68 (50m/24h)	TH385	200

(1) Dimensions are intended when the connectors are inserted

(3) Supplied with the fixing nut

(2) Plug versions. For related socket versions see codes of the TH384 series

(4) Approved for use with class 2 devices (only for 2 poles versions)

## TEEPLUG®: mount plug&socket connectors (IP68)



With fixing nut

External dimensions (mm) <sup>(1)</sup>	N. Poles min - max	Wire cross section min - max (mm <sup>2</sup> )	Code <sup>(2)(3)</sup>	Thread	Technical data	IP Grade	Series	Pieces/box
ø36.5 x 70	2 - 3	0.5 - 4.0	THB.406.A1B	M28	25A - 400V	IP68 (10m/1h)	TH406	200
ø36.5 x 70	2 - 3 - 4 - 5	0.5 - 4.0	THB.406.A1A	M28	17.5A - 400V	IP68 (10m/1h)	TH406	200
ø36.5 x 70	2 - 3 - 4 - 5 - 6	0.5 - 4.0	THB.406.A1E	M28	17.5A - 400V	IP68 (10m/1h)	TH406	200

(1) Dimensions are intended when the connectors are inserted

(3) Supplied with the fixing nut

(5) Approved for use with class 2 devices (only for 2 poles versions)

(2) Plug versions. For related socket versions see codes of the TH405 series

(4) UL approvals only for 3 and 5 poles (learn more on [www.techno.it](http://www.techno.it))

## mini-TEEPLUG®: mini plug&socket connectors with insulation piercing system (IP68)

For single-pole main cables



TH370

External dimensions (mm) <sup>(1)</sup>	N. Poles min - max	Main cable cross section min - max (mm <sup>2</sup> )	Main cable diameter min - max (mm)	Code	Technical data	IP Grade	Series	Pieces/box
32 x 44 x 130	2	2.5 - 4.0	6.0 - 7.0	THB.370.A2A <sup>(2)</sup>	17.5A - 400V	IP68	TH370	200
32 x 44 x 130	2	4.0 - 6.0	7.0 - 8.0	THB.370.B2A <sup>(2)</sup>	17.5A - 400V	IP68	TH370	200

(1) Dimensions are intended when the connectors are inserted (2) Socket versions. For the related plug version order the code THB.384.P2A

## mini-TEEPLUG®: mini plug&socket ultra flat connector (IP67)



TH420

External dimensions (mm) <sup>(1)</sup>	N. Poles min - max	Main cable cross section min - max (mm <sup>2</sup> )	Code <sup>(2)</sup>	Technical data	IP Grade	Series	Pieces/box
22 x 84 x 4	2	0.75	THH.420.A2A	6A - 230V	IP67	TH420	200

(1) Dimensions are intended when the connectors are inserted (2) Plug and socket are supplied together

Note: plug and socket connectors are supplied with over-molded cable (H03V2V2-F, 2x0.75mm<sup>2</sup>). Cable length is 450 mm for both sides.



**Products with piercing screw terminal blocks (see page 8)**  
In addition to products with screw terminal blocks, piercing screw connectors are available for cable section from 0.5 mm<sup>2</sup> to 1.5mm<sup>2</sup> (max. 17.5A). Approved with PVC, Neoprene and FEP cables.

How to order CODE THP.xxx.xxx  
example

THP.391.A4A  
products with piercing screws

THB.391.A4A  
products with standard screws



TH386. Quick fixing on circular or flat panel without the use of the fixing nut.



TH386. Pluggable installation when used in combination with TH384 connectors.



TH370. Quick installations of the main cable with the insulation piercing clip connector.



TH370. Pluggable installation of the branch cable when used in combination with TH384 connectors.

## TEEDRUM®: mini compact circular connectors (IP20)



TH021



TH033

External dimensions (mm)	N. Poles min - max	Wire cross section min - max (mm <sup>2</sup> )	Code	Technical data	IP Grade	Series	Pieces/box
ø22 x 26	2 - 3	0.5 - 4.0	THB.021.A1A	32A - 450V	IP20	TH021	400
23 x 22 x 24	2 - 3 - 4	0.5 - 4.0	THB.033.A4A	32A - 450V	IP00	TH033	400
ø26 x 26	2 - 3 - 4 - 5	0.5 - 4.0	THB.021.B1A	32A - 450V	IP20	TH021	400

## TEEBLOCK®: mini compact linear connectors (IP00)

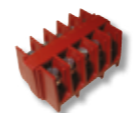

TH026



TH029



TH032

External dimensions (mm)	N. Poles min - max	Wire cross section min - max (mm <sup>2</sup> )	Code	Technical data	IP Grade	Series	Pieces/box
21 x 20.6 x 16.4	2 - 3	0.5 - 4.0	THB.026.B1A	32A - 450V	IP00	TH026	400
30.6 x 20.6 x 15.8	2 - 3	0.5 - 4.0	THB.029.A1A <sup>(1)</sup>	32A - 450V	IP00	TH029	400
29 x 44 x 16	2 - 3	1.5 - 6.0	THC.027.A1A	41A - 450V	IP00	TH027	400
50.7 x 20.8 x 21	2 - 3 - 4	0.5 - 4.0	THB.032.A4B <sup>(1)</sup>	32A - 450V	IP00	TH032	400
32 x 21 x 16.4	2 - 3 - 4 - 5	0.5 - 4.0	THB.026.A1A	32A - 450V	IP00	TH026	400

(1) Current distributor with double connection (see page 17) Note: TEEBLOCK® connectors are approved for use with stranded and solid cables

## TEEBLOCK®: mini compact in-out terminal block with crimp/screw connection (IP54)



TH112

External dimensions (mm)	N. Poles min - max	Wire cross section min - max (mm <sup>2</sup> )	Code	Technical data	IP Grade	Series	Pieces/box
21 x 46.3 x 12.6	2 - 3	0.5 - 1.5	THP.112.A3A	17.5A - 450V	IP54	TH112	400

Note: visit [www.techno.it](http://www.techno.it) to learn more on crimp contacts usable with this product. See page 17 for more information on TH112

## TEEGLAND®: innovative cable glands in co-molding (IP68)



Thread	Colour	Outer cable diameter (mm)	Code (cable gland)	Code (fixing nut) <sup>(1)</sup>	IP Grade	Series	Pieces/box
PG9	black	4.0 - 7.5	THA.450.A1A	6000046CC	IP68 (50m/1h)	TH450	500
PG9	black	7.5 - 9.5	THA.450.B1A	6000046CC	IP68 (50m/1h)	TH450	500
PG13.5	black	7.0 - 10.5	THA.451.B1A	604003200	IP68 (50m/1h)	TH451	500
PG13.5	black	10.5 - 14.0	THA.451.C1A	604003200	IP68 (50m/1h)	TH451	500
PG16	black	7.0 - 10.5	THA.451.B2A	6040050CC	IP68 (50m/1h)	TH451	500
PG16	black	10.5 - 14.0	THA.451.C2A	6040050CC	IP68 (50m/1h)	TH451	500
M16	black	4.0 - 7.5	THA.450.A0A	6000046CC	IP68 (50m/1h)	TH450	500
M16	black	7.5 - 9.5	THA.450.B0A	6000046CC	IP68 (50m/1h)	TH450	500
M20	black	7.0 - 10.5	THA.451.B0A	6000157CC	IP68 (50m/1h)	TH451	500
M20	black	10.5 - 14.0	THA.451.C0A	6000157CC	IP68 (50m/1h)	TH451	500
M25	black	7.0 - 10.5	THA.452.B1A	6000212CC	IP68 (50m/1h)	TH452	500
M25	black	10.5 - 14.0	THA.452.C1A	6000212CC	IP68 (50m/1h)	TH452	500
M25	black	14.0 - 17.0	THA.452.B0A	6000212CC	IP68 (50m/1h)	TH452	500

Thread	Colour	Outer cable diameter (mm)	Code (cable gland)	Code (fixing nut) <sup>(1)</sup>	IP Grade	Series	Pieces/box
PG9	grey	4.0 - 7.5	THA.450.A1E	6000046CC	IP68 (50m/1h)	TH450	500
PG9	grey	7.5 - 9.5	THA.450.B1E	6000046CC	IP68 (50m/1h)	TH450	500
PG13.5	grey	7.0 - 10.5	THA.451.B1E	604003200	IP68 (50m/1h)	TH451	500
PG13.5	grey	10.5 - 14.0	THA.451.C1E	604003200	IP68 (50m/1h)	TH451	500
PG16	grey	7.0 - 10.5	THA.451.B2E	6040050CC	IP68 (50m/1h)	TH451	500
PG16	grey	10.5 - 14.0	THA.451.C2E	6040050CC	IP68 (50m/1h)	TH451	500
M16	grey	4.0 - 7.5	THA.450.A0E	6000046CC	IP68 (50m/1h)	TH450	500
M16	grey	7.5 - 9.5	THA.450.B0E	6000046CC	IP68 (50m/1h)	TH450	500
M20	grey	7.0 - 10.5	THA.451.B0E	6000157CC	IP68 (50m/1h)	TH451	500
M20	grey	10.5 - 14.0	THA.451.C0E	6000157CC	IP68 (50m/1h)	TH451	500
M25	grey	7.0 - 10.5	THA.452.B1E	6000212CC	IP68 (50m/1h)	TH452	500
M25	grey	10.5 - 14.0	THA.452.C1E	6000212CC	IP68 (50m/1h)	TH452	500
M25	grey	14.0 - 17.0	THA.452.B0E	6000212CC	IP68 (50m/1h)	TH452	500

(1) The fixing nut is not included. To be ordered separately (black colour)



Colour versions available upon request.

To learn more about products, accessories and technical information see our **General Catalogue** or visit [www.techno.it](http://www.techno.it)

## Project references:

electrical connections under the most extreme conditions



Connection of LED industrial lighting for automotive industry (Germany).  
**Series TH405/TH406 (silicon free).**



Connection of street lighting LED Luminaires (Rome, Italy).  
**Series TH405.**



Connection of luminaires for Supertree Grove, Garden by the Bay (Singapore).  
**Series TH400.**



Connection of facade lighting devices at Birmingham library (UK).  
**Series TH405/TH631.**



Connection of LED luminaires (Penang, Malaysia).  
**Series TH387.**



Connection of street lighting devices at F1 Grand Prix (Singapore).  
**Series TH405.**



Connection of submersible pumps (France).  
**Series TH400.**



Connection of lighting points on a sailing boat (New Zealand).  
**Series TH387.**



Connection of LED luminaires in cold rooms on a FPSO vessel (Singapore).  
**Series TH387.**



Connection of LED luminaires in a car washing plant (New Zealand).  
**Series TH387.**



Wall mount connection on a control panel of a bottled water plant (Australia).  
**Series TH387.**



Connection of liquid level sensors (Shanghai, China).  
**Series TH451.**



Connection of generators for a server room UPS (New Zealand).  
**Series TH405.**



Connection of motors (Germany).  
**Series TH450.**



Connection of heating cables (Italy).  
**Series TH211.**



## International client experience

### The industrial and creative process.

From its *client experience* Techno has developed the innovative, complete and customized solution for electrical connections.

**FUNCTIONAL\_CREATIVITY +  
FOREFRONT\_TECHNOLOGIES +  
INNOVATIVE\_MATERIALS =**

### MORE RELIABLE AND AFFORDABLE SOLUTIONS

The continuous analysis of the application conditions and operational modalities in the factory and site over the last 10 years have enabled Techno to develop specific solutions which have become off-the-shelf products. This results in higher quality together with cheaper installation, maximum reliability and easy maintenance.

Techno continues to offer customizable products and, at the same time, it has strengthened its designing and productive structure to developed ad hoc customized solutions. With an Italian design and all the positive characteristics of "made in Italy" products.



**Techno s.r.l.**

Via Bancora e Rimoldi, 27  
22070 Guanzate (CO), Italy  
Ph. +39 031 976445

[www.techno.it](http://www.techno.it)

Techno reserves the right to make any adjustments to the information contained herein at any time without notice. The dimensions and the specifications in this catalogue are for reference purpose only and are subject to change without notice. Consult Techno for the latest dimensions and design specifications or visit our web site [www.techno.it](http://www.techno.it)

MADE IN ITALY